

## Low Noise Charge Pump/Linear Regulator LED Driver

### Features

- Low noise regulator with integrated charge pump voltage-booster
- 5V output with input voltage as low as 2.8V
- Charge pump can also power an external LDO
- Low noise in 20Hz to 20kHz audio band
- Up to 200mA continuous output current
- Low operating and shutdown currents
- Stable with low-ESR ceramic or tantalum capacitors
- Over-current and over-temperature protection
- 10-lead TDFN package, 3mm x 3mm
- Lead-free versions available

### Applications

- White backlight LEDs for main display in wireless handsets and LCD modules
- Power flash LEDs for camera phones
- 3.3V to 5V conversion in PCMCIA cards, PCI Express Cards, other applications needing 5V
- 5V analog supply for audio codec in notebook computers, PDAs, MP3 players, etc

### Product Description

The CM4072 Low-noise Charge Pump / LDO Regulator is designed to power white backlight LEDs used in main displays or camera flash LEDs in wireless handsets. The 5V output provides up to 100mA continuous current for input voltages from 3.0V to 5.5V, and up to 200mA for a narrower range. This is accomplished with an integrated charge pump that boosts the input voltage before feeding it to an internal LDO linear regulator. The CM4072 operates with excellent power supply ripple rejection while maintaining good power efficiency. The device utilizes two external capacitors and operates at 250kHz. Separate analog and digital ground pins are provided for the charge pump and the rest of the circuitry to eliminate ground noise feed-through from the charge pump to the regulated output.

The CM4072 provides both overcurrent and thermal overload protection. Two enable inputs provide flexibility in powering down the device. To maximize power saving in shutdown mode, both enable inputs should be at a logic low level. For applications that require the 5V output to be re-established with minimum delay after shutdown, the charge pump can be left enabled while the regulator is disabled. The CMOS LDO regulator features low quiescent current even at full load, making it very suitable for power sensitive applications.

A bypass pin is provided to further minimize noise by connecting an external capacitor between this pin and ground.

The CM4072 is available in a 10-lead TDFN package, with optional lead-free finishing, and is ideal for space critical applications.

### Typical Application

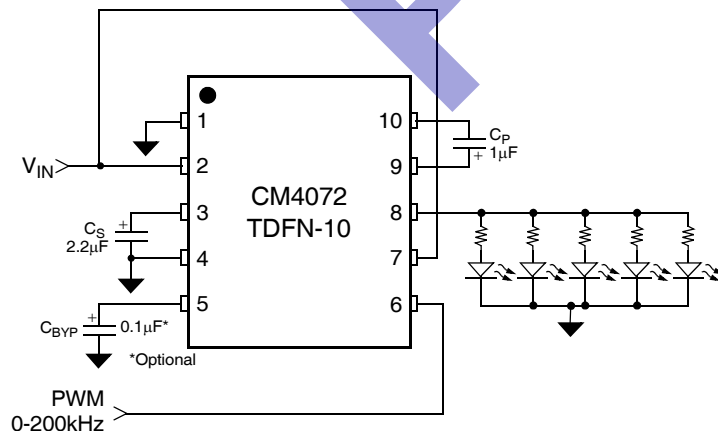

### Simplified Block Diagram

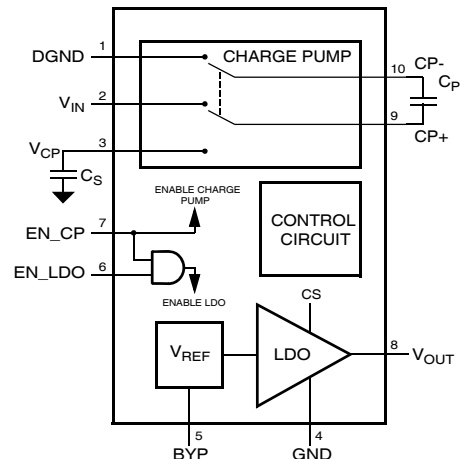

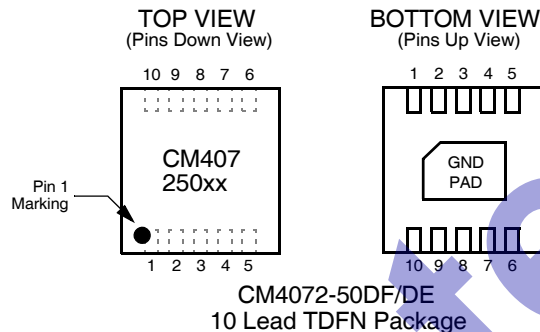
**PACKAGE / PINOUT DIAGRAM**

Note: This drawing is not to scale.

**PIN DESCRIPTIONS**

| LEAD(S)       | NAME           | DESCRIPTION  |               |                |             |           |   |   |         |         |   |   |         |          |   |   |          |          |   |   |          |          |
|---------------|----------------|--|---------------|----------------|-------------|-----------|---|---|---------|---------|---|---|---------|----------|---|---|----------|----------|---|---|----------|----------|
| 1             | DGND           | Ground for the charge pump circuit. This should be connected to the system (noisy) ground.   |               |                |             |           |   |   |         |         |   |   |         |          |   |   |          |          |   |   |          |          |
| 2             | $V_{IN}$       | Input power source for the device. Since the charge pump draws current in pulses at the 250kHz internal clock frequency, a low-ESR input decoupling capacitor is usually required close to this pin to ensure low noise operation.   |               |                |             |           |   |   |         |         |   |   |         |          |   |   |          |          |   |   |          |          |
| 3             | $V_{CP}$       | Charge pump output which is connected to the external reservoir capacitor $C_S$ . This should be a low-ESR capacitor. When the voltage on this pin reaches about 5.8V then the charge pump pauses until the voltage on this pin drops to about 5.7V. This gives rise to at least 100mV of 'ripple' (the frequency and amplitude of this ripple depends upon values of $C_P$ and $C_S$ and also the ESR of $C_S$ ).   |               |                |             |           |   |   |         |         |   |   |         |          |   |   |          |          |   |   |          |          |
| 4             | GND            | Ground reference for all internal circuits except the charge pump. This pin should be connected to a "clean" low-noise analog ground   |               |                |             |           |   |   |         |         |   |   |         |          |   |   |          |          |   |   |          |          |
| 5             | BYP            | Bypass input connected to the internal voltage reference of the LDO regulator. An external bypass capacitor $C_{BYP}$ of 0.1uF is recommended to minimize internal voltage reference noise and maximize power supply ripple rejection.   |               |                |             |           |   |   |         |         |   |   |         |          |   |   |          |          |   |   |          |          |
| 6, 7          | EN_LDO, EN_CP  | EN_LDO (pin 6) and EN_CP (pin 7) are active-high TTL-level logic inputs to enable the linear regulator and charge pump according to the following truth table: <table border="1" style="margin: 10px auto;"> <thead> <tr> <th>EN_CP (Pin 7)</th> <th>EN_LDO (Pin 6)</th> <th>CHARGE PUMP</th> <th>REGULATOR</th> </tr> </thead> <tbody> <tr> <td>1</td> <td>1</td> <td>Enabled</td> <td>Enabled</td> </tr> <tr> <td>1</td> <td>0</td> <td>Enabled</td> <td>Disabled</td> </tr> <tr> <td>0</td> <td>1</td> <td>Disabled</td> <td>Disabled</td> </tr> <tr> <td>0</td> <td>0</td> <td>Disabled</td> <td>Disabled</td> </tr> </tbody> </table> | EN_CP (Pin 7) | EN_LDO (Pin 6) | CHARGE PUMP | REGULATOR | 1 | 1 | Enabled | Enabled | 1 | 0 | Enabled | Disabled | 0 | 1 | Disabled | Disabled | 0 | 0 | Disabled | Disabled |
| EN_CP (Pin 7) | EN_LDO (Pin 6) | CHARGE PUMP  | REGULATOR     |                |             |           |   |   |         |         |   |   |         |          |   |   |          |          |   |   |          |          |
| 1             | 1              | Enabled  | Enabled       |                |             |           |   |   |         |         |   |   |         |          |   |   |          |          |   |   |          |          |
| 1             | 0              | Enabled  | Disabled      |                |             |           |   |   |         |         |   |   |         |          |   |   |          |          |   |   |          |          |
| 0             | 1              | Disabled   | Disabled      |                |             |           |   |   |         |         |   |   |         |          |   |   |          |          |   |   |          |          |
| 0             | 0              | Disabled   | Disabled      |                |             |           |   |   |         |         |   |   |         |          |   |   |          |          |   |   |          |          |
| 8             | $V_{OUT}$      | The regulated output. An output capacitor may be added to improve noise and load-transient response. When the LDO regulator is disabled, an internal pull-down with a nominal resistance of 50 ohms is activated to discharge the $V_{OUT}$ rail to GND  |               |                |             |           |   |   |         |         |   |   |         |          |   |   |          |          |   |   |          |          |
| 9, 10         | CP+, CP-       | CP+ (pin 9) and CP- (pin 10) are used to connect the external "flying" capacitor $C_P$ to the charge pump. The charge stored in $C_P$ is transferred to the reservoir capacitor $C_S$ at the 250kHz internal clock rate.   |               |                |             |           |   |   |         |         |   |   |         |          |   |   |          |          |   |   |          |          |

**Ordering Information**

| <b>PART NUMBERING INFORMATION</b> |         |                                   |              |                                   |              |
|-----------------------------------|---------|-----------------------------------|--------------|-----------------------------------|--------------|
| Leads                             | Package | Standard Finish                   |              | Lead-free Finish                  |              |
|                                   |         | Ordering Part Number <sup>1</sup> | Part Marking | Ordering Part Number <sup>1</sup> | Part Marking |
| 10                                | TDFN-10 | CM4072-50DF                       | CM407 250DF  | CM4072-50DE                       | CM407 250DE  |

Note 1: Parts are shipped in Tape & Reel form unless otherwise specified.

**Specifications**

| <b>ABSOLUTE MAXIMUM RATINGS</b>                 |  |       |
|---|--|-------|
| PARAMETER                                       | RATING                                 | UNITS |
| ESD Protection (HBM)                            | ±2000                                  | V     |
| V <sub>EN</sub> Logic Input Voltage             | (V <sub>IN</sub> + 0.5) to (GND - 0.5) | V     |
| V <sub>IN</sub> , V <sub>OUT</sub> Pin Voltages | +5.5 to (GND - 0.5)                    | V     |
| Storage Temperature Range                       | -65 to +150                            | °C    |
| Operating Temperature Range                     |  |       |
| Ambient   | -40 to +85                             | °C    |
| Junction  | -40 to +150                            | °C    |

| <b>STANDARD OPERATING CONDITIONS</b>    |               |       |
|---|---------------|-------|
| PARAMETER                               | VALUE         | UNITS |
| Input Voltage Range (V <sub>IN</sub> )  | 2.8 to 5.5    | V     |
| Ambient Operating Temperature           | -40 to +85    | °C    |
| θ <sub>JA</sub> of TDFN package on PCB  | 200 (approx.) | °C/W  |
| Output Load Current (I <sub>OUT</sub> ) | 0 to 200      | mA    |
| C <sub>BYP</sub>                        | 0.1           | μF    |
| C <sub>OUT</sub>                        | 0 to 100      | μF    |

| <b>RECOMMENDED EXTERNAL COMPONENTS</b> |       |       |
|--|-------|-------|
| DEVICE                                 | VALUE | UNITS |
| C <sub>S</sub>                         | 2.2   | μF    |
| C <sub>P</sub>                         | 1.0   | μF    |

**Specifications (cont'd)**

| <b>ELECTRICAL OPERATING CHARACTERISTICS (SEE NOTE 1)</b> |  |  |            |            |            |              |
|--|--|--|------------|------------|------------|--------------|
| <b>SYMBOL</b>  | <b>PARAMETER</b>                             | <b>CONDITIONS</b>  | <b>MIN</b> | <b>TYP</b> | <b>MAX</b> | <b>UNITS</b> |
| V <sub>CP</sub>  | Charge Pump Output Voltage                   | V <sub>OUT</sub> = 5V, 1mA ≤ I <sub>OUT</sub> ≤ 100mA  | 5.5        | 5.8        | 7          | V            |
| V <sub>OUT</sub>   | Regulator Output Voltage                     | V <sub>IN</sub> = 4.0V, 1mA ≤ I <sub>OUT</sub> ≤ 100mA   | 4.85       |            | 5.15       | V            |
| V <sub>R LOAD</sub>                                      | Load Regulation                              | I <sub>OUT</sub> = 1mA to 100mA  |            | 0.2        |            | %            |
| V <sub>R LINE</sub>                                      | Line Regulation                              | Vary V <sub>IN</sub> from 3.0V to 5.0V   |            | 0.02       |            | %            |
| R <sub>DISCHG</sub>                                      | V <sub>OUT</sub> Discharge Resistance        | LDO regulator disabled, EN_LDO grounded, V <sub>IN</sub> = 5V  |            | 500        |            | Ω            |
| I <sub>GND</sub>   | LDO Regulator Ground Current via the GND pin | Shutdown (EN_LDO grounded)   |            | 1          | 10         | μA           |
|  |  | Regulator Enabled, I <sub>OUT</sub> = 0mA  |            | 180        |            | μA           |
|  |  | Regulator Enabled, I <sub>OUT</sub> = 100mA  |            | 180        |            | μA           |
| I <sub>DGND</sub>  | Charge Pump Shutdown Current via DGND pin    | EN_CP grounded, V <sub>IN</sub> = 5V   |            | 1          | 10         | μA           |
| PSRR   | Power Supply Ripple Rejection                | I <sub>OUT</sub> = 100mA, C <sub>BYP</sub> = 0.1μF, Note 2   |            | 42         |            | dB           |
|  |  | f = 100Hz  |            | 42         |            |              |
| e <sub>NO</sub>  | Output Voltage Noise                         | BW=22Hz-22kHz, C <sub>OUT</sub> = 10μF, C <sub>BYP</sub> = 0.1μF, I <sub>OUT</sub> = 100mA, Note 2                                       |            | 35         |            | μVrms        |
|  |  | BW=22Hz-22kHz, C <sub>P</sub> = 1μF, C <sub>S</sub> = 3μF, C <sub>OUT</sub> = C <sub>BYP</sub> = 0.1μF, I <sub>OUT</sub> = 100mA, Note 2 |            | 38         |            | μVrms        |
| V <sub>IH</sub>  | EN_CP, EN_LDO Input High Threshold           | V <sub>IN</sub> = 5.0V   | 2.0        |            |            | V            |
| V <sub>IL</sub>  | EN_CP, EN_LDO Input Low Threshold            | V <sub>IN</sub> = 5.0V   |            |            | 0.5        | V            |
| I <sub>LIM</sub>   | Overload Current Limit                       | LDO Only, Note 2   | 200        | 300        |            | mA           |
| I <sub>SC</sub>  | Output Short Circuit Current                 | LDO Only, Note 2   |            | 50         |            | mA           |
| T <sub>JSD</sub>   | Thermal Shutdown Junction Temperature        |  |            | 170        |            | °C           |
| T <sub>HYS</sub>   | Thermal Shutdown Hysteresis                  |  |            | 25         |            | °C           |

Note 1: Unless otherwise noted, electrical operating characteristics are specified with T<sub>A</sub> = 0 to 70°C, V<sub>IN</sub> = 5.0V, I<sub>OUT</sub> = 100mA, C<sub>OUT</sub> = 10μF, C<sub>P</sub> = 1μF, C<sub>S</sub> = 10μF.

Note 2: These parameters are guaranteed by design and characterization.

**Performance Information**

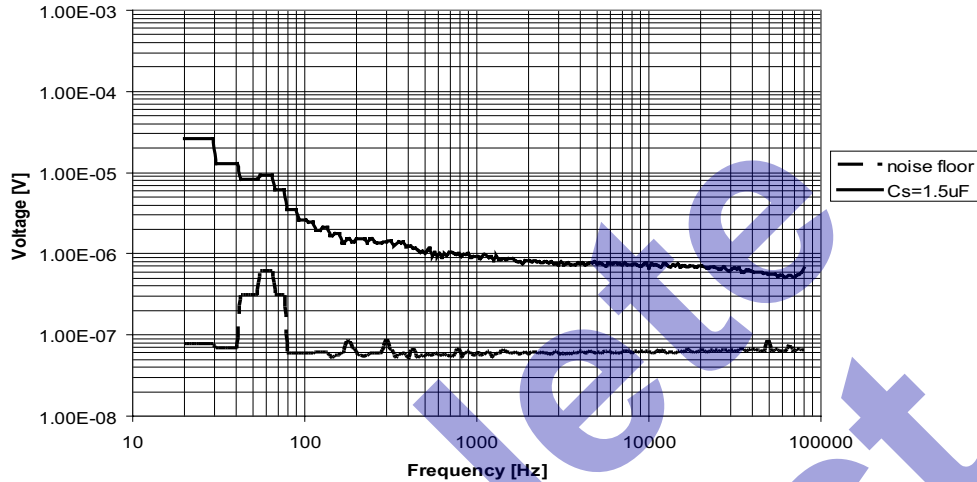

Note: Noise peaks may appear for different values of  $C_P$ ,  $C_S$  &  $I_{OUT}$ , and are due to the ripple frequency of the charge pump (see later).

**Figure 1. CM4072 Noise Spectrum (  $T_A = 25^\circ\text{C}$ ,  $C_P=0.47\mu\text{F}$ ,  $C_S = 1.5\mu\text{F}$ ,  $C_{OUT} = 10\mu\text{F}$ ,  $C_{BYP} = 0.1\mu\text{F}$ ,  $I_{OUT} = 100\text{mA}$  )**

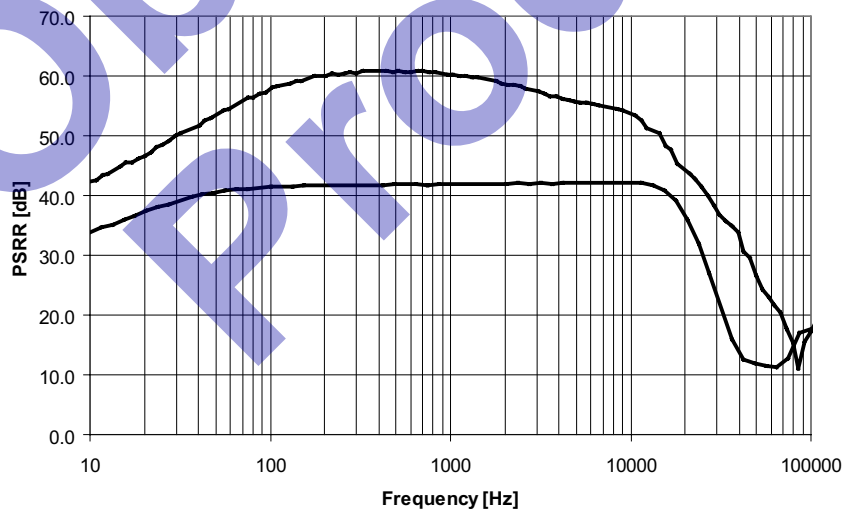

Measured by forcing  $V_{IN}$  voltage to 3.3V & 5.0V dc, then sweeping 100mV ac on  $V_{IN}$ .  $C_{OUT} = 10\mu\text{F}$ ,  $C_{BYP} = 0.1\mu\text{F}$ .

**Figure 2. CM4072 PSRR (upper curve with  $V_{IN} = 3.3\text{V}$ , lower curve with  $V_{IN} = 5\text{V}$ ,  $I_{OUT} = 100\text{mA}$  both cases)**

**Performance Information (cont'd)**

Typical DC Characteristics ( $T_A=25^\circ\text{C}$ ,  $C_P=1.0\mu\text{F}$ ,  $C_S=10\mu\text{F}$ ,  $C_{BYP}=0.1\mu\text{F}$ ,  $C_{OUT}=10\mu\text{F}$  unless otherwise noted)

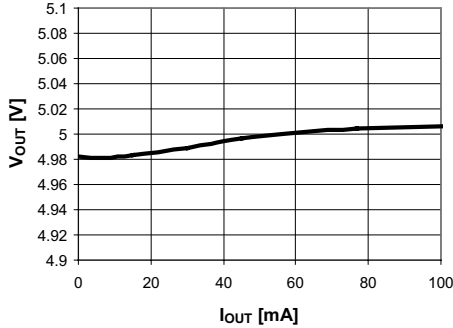

**Figure 3.  $V_{OUT}$  vs.  $I_{OUT}$  ( $V_{IN} = 5\text{V}$ )**

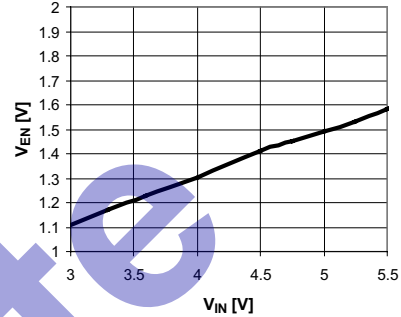

**Figure 7.  $V_{EN}$  Threshold vs.  $V_{IN}$**

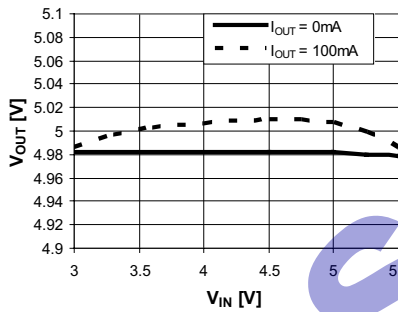

**Figure 4.  $V_{OUT}$  vs.  $V_{IN}$**

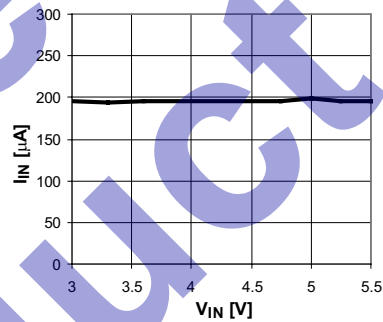

**Figure 8.  $I_{IN}$  vs.  $V_{IN}$**

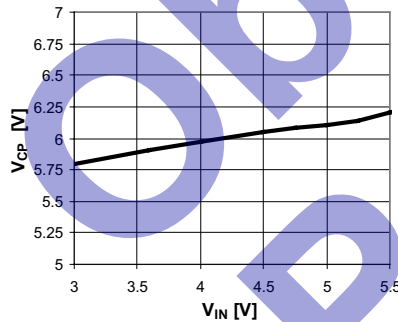

**Figure 5. CS Pin vs.  $V_{IN}$**

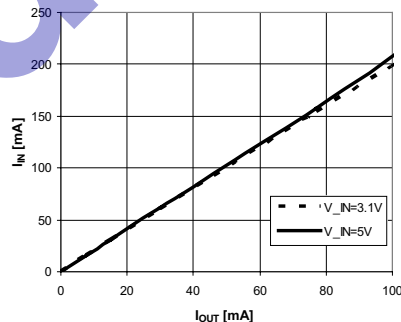

**Figure 9.  $I_{IN}$  vs.  $I_{OUT}$**

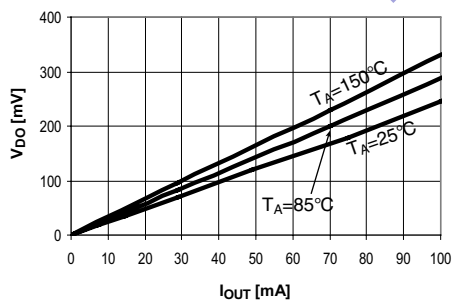

**Figure 6. Dropout Voltage (LDO Only)**

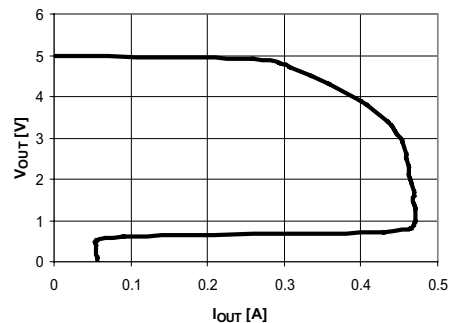

**Figure 10. Overcurrent Characteristic (LDO only)**

**Performance Information (cont'd)**

Transient Characteristics ( $T_A=25^{\circ}\text{C}$ ,  $C_P=1.0\mu\text{F}$ ,  $C_S=10\mu\text{F}$ ,  $C_{BYP}=0.1\mu\text{F}$ ,  $C_{OUT}=10\mu\text{F}$  unless otherwise noted)

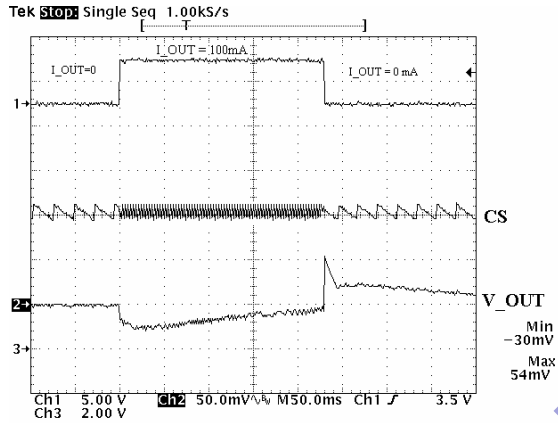

**Figure 11. Load Regulation (0mA to 100mA)**

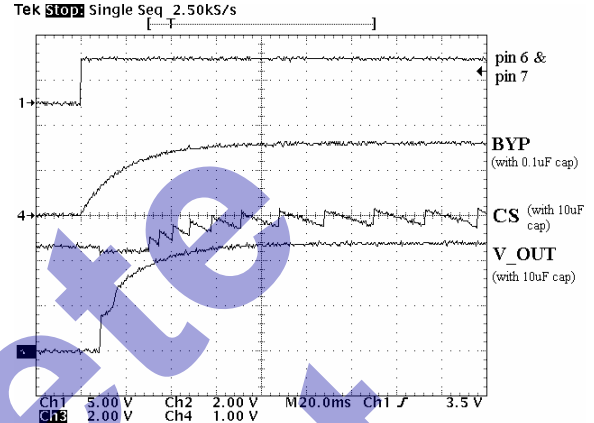

**Figure 14. Cold Start / Power-Up**

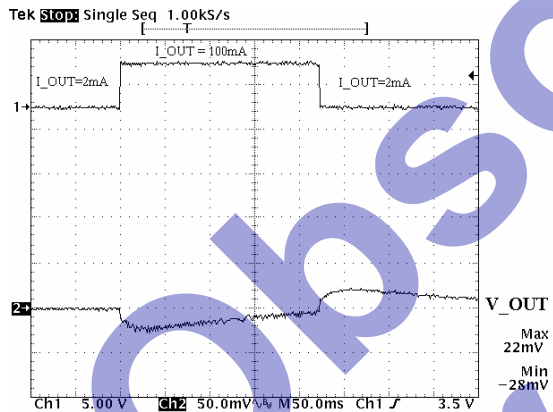

**Figure 12. Load Regulation (2mA to 100mA)**

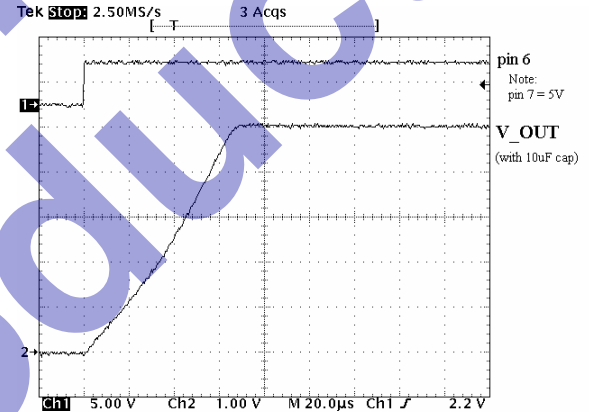

**Figure 15. LDO Power-Up**

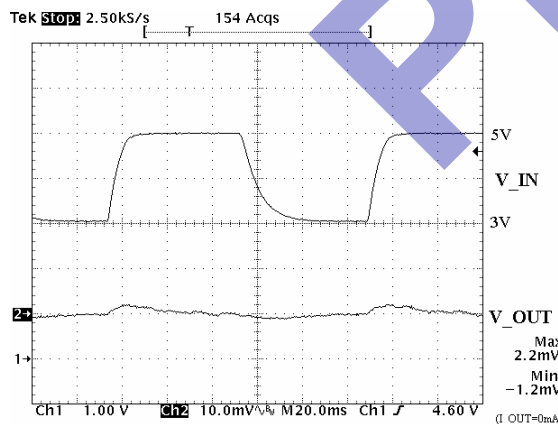

**Figure 13. Line Regulation**

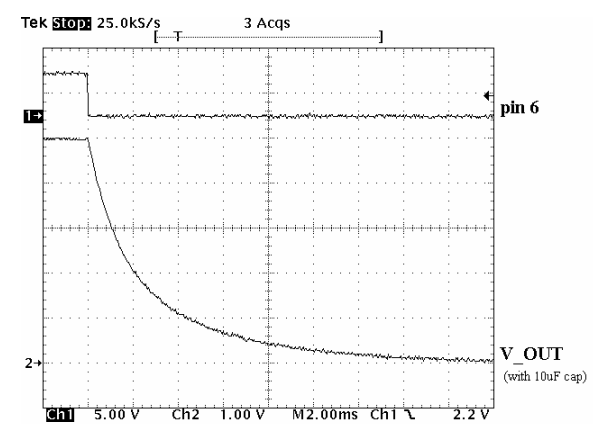

**Figure 16. LDO Power-Down**

**Performance Information (cont'd)**

Transient Characteristics ( $T_A=25^\circ\text{C}$ ,  $V_{IN}=5\text{V}$ ,  $C_P=1.0\mu\text{F}$ ,  $C_S=10\mu\text{F}$ ,  $C_{BYP}=0.1\mu\text{F}$ ,  $C_{OUT}=10\mu\text{F}$  unless otherwise noted)

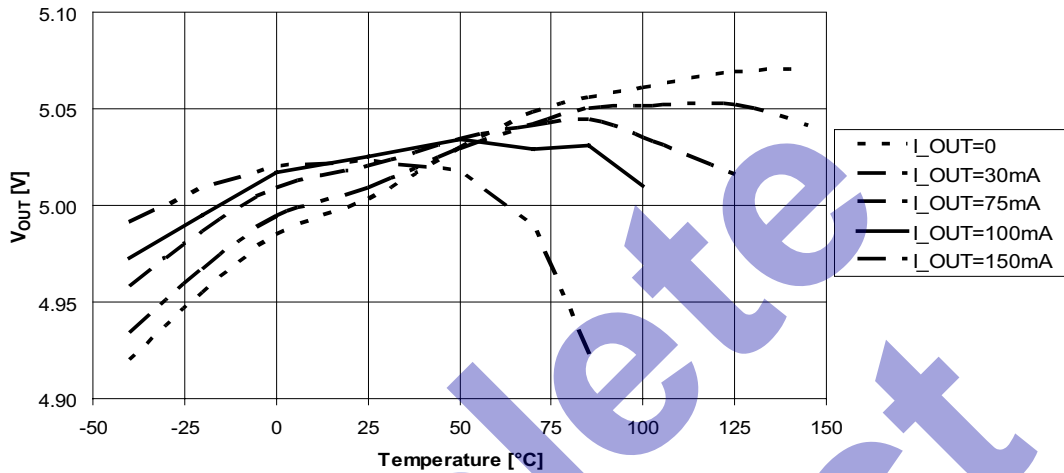

**Figure 17.  $V_{OUT}$  with  $V_{IN} = 5\text{V}$**

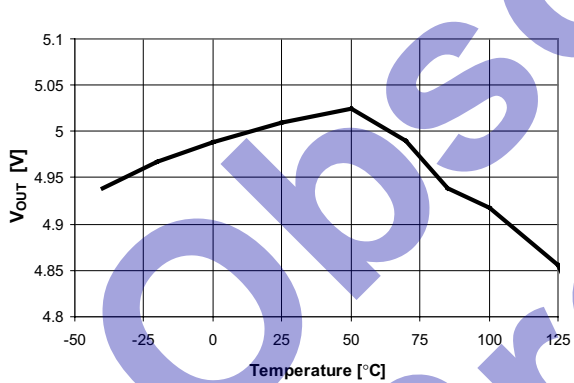

**Figure 18.  $V_{OUT}$  with  $V_{IN}=3.0\text{V}$ ,  $I_{OUT}=100\text{mA}$**

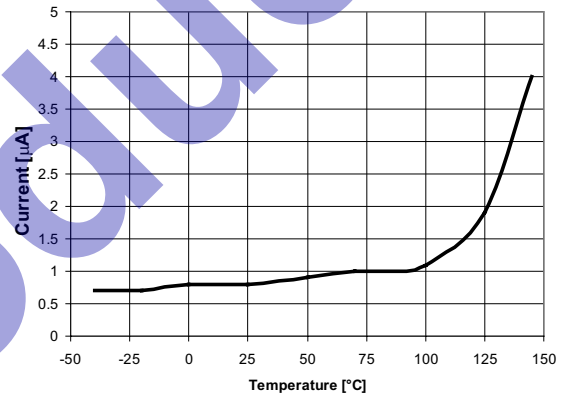

**Figure 20.  $I_{IN}$  Leakage Current (Pins 6,7=0V)**

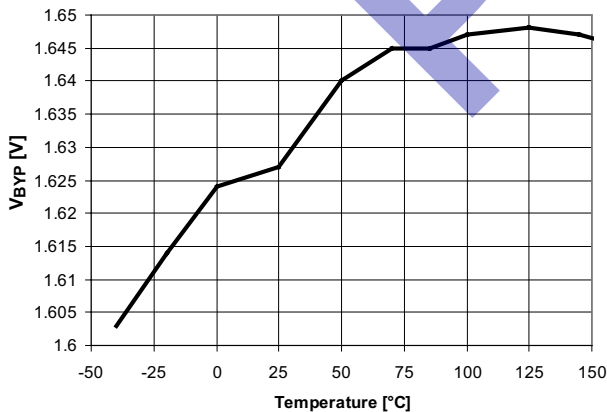

**Figure 19. Bypass Pin Voltage**

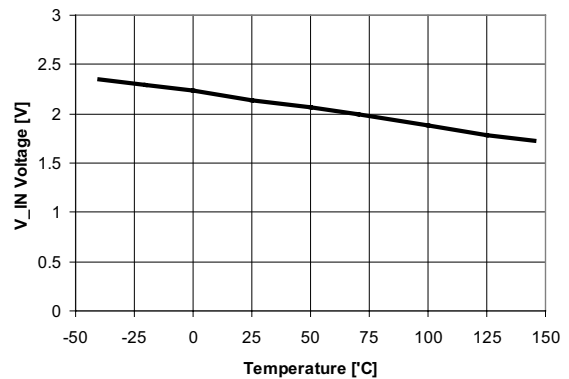

**Figure 21. Undervoltage Lockout**

## Application Information

### Ripple Frequency

The charge pump internal oscillation frequency is about 250kHz. However, this is the continuous, free-running frequency, which is usually only seen while the charge pump is powering up. Such a sawtooth 'ripple' waveform on CS can have a much lower frequency than 250kHz. This mode of operation is necessary to conserve power. If it were not done this way, then a much larger package with heatsink would be required.

The frequency of this 'ripple' is affected by  $V_{IN}$ ,  $I_{OUT}$ ,  $C_S$  capacitor value and  $C_P$  capacitor value.

### Guidelines for External Capacitors

(1) To find  $C_P$ : specify value of  $V_{IN}$ , and highest value of  $I_{OUT}$ :

If  $V_{IN} = 3.3V \pm 5\%$ , then minimum value of  $C_P (\mu F) = I_{OUT} (mA) / 85$ .

If  $V_{IN} = 5.0V \pm 10\%$ , then minimum value of  $C_P (\mu F) = I_{OUT} (mA) / 700$

(2) The  $V_{IN}$  decoupling capacitor,  $C_{IN}$ , should typically be much greater than  $C_P$  to prevent voltage droop during  $C_P$  charging. Excessive glitches on  $V_{IN}$  will affect the output voltage  $V_{OUT}$ .  $C_{IN}$  is typically 10X greater than  $C_P$ .

(3)  $C_S$  should be small to ensure that the ripple frequency is high, but at least 2x greater than  $C_P$ , otherwise the ripple amplitude will be very high. Reducing the value of  $C_S$  will increase the ripple frequency.

Examples of  $C_S$  ripple frequencies ( $C_S = 10\mu F$ ,  $T_A = 25^\circ C$ ) are shown in following tables:

| $C_P = 0.47\mu F$ |           |                 |
|-------------------|-----------|-----------------|
| $V_{IN}$          | $I_{OUT}$ | $C_S$ Frequency |
| 3.14              | 15mA      | 46kHz           |
| 3.60              | 15mA      | 35kHz           |
| 4.50              | 70mA      | 76kHz           |
| 5.50              | 70mA      | 56kHz           |

| $C_P = 1.0\mu F$ |           |                 |
|------------------|-----------|-----------------|
| $V_{IN}$         | $I_{OUT}$ | $C_S$ Frequency |
| 3.14             | 100mA     | 250kHz          |
| 3.60             | 100mA     | 110kHz          |
| 4.50             | 100mA     | 67kHz           |
| 5.50             | 100mA     | 49kHz           |

(4)  $C_{OUT}$ , the optional  $V_{OUT}$  capacitor, helps minimize noise and improve load regulation;  $0.1\mu F$  to  $100\mu F$  is recommended.

(5)  $C_{BYP}$ , the optional bypass capacitor helps reduce noise in the LDO;  $0.1\mu F$  is recommended.

After choosing external component values, check in-system performance (at min/max  $V_{IN}$ , max temperature, and min/max  $I_{OUT}$ ). See the troubleshooting guide on next page for tips if there are problems.

### Charge Pump Noise

The charge pump is 'digital' in operation and can produce digital noise at both the free-running frequency and at the ripple frequency.

To minimize noise, PCB grounding is important! This part requires short, low-impedance ground connections for DGND (pin 1), GND (pin 4), the  $V_{IN}$  decoupling capacitor (pin 2), the  $C_S$  capacitor (pin 3), the Bypass decoupling capacitor (pin 5) and the  $V_{OUT}$  decoupling capacitor (pin 8). All decoupling capacitors and the  $C_S$  capacitor should be low-ESR ceramics. The  $C_P$  capacitor needs to be low-ESR.

### Efficiency

The power efficiency in % of the combined charge pump and LDO is approximately:

$$100 \times (V_{OUT}) / (V_{IN} \times 2)$$

### Power Dissipation

The dissipation of the part is approximately:

$$((V_{IN} \times 2) - V_{OUT}) \times I_{OUT}$$

The TDFN-10 package heats at a rate of about 200°C/W ( $\theta_{JA}$ ). Note that this value is approximate because it depends upon the copper tracks and ground planes on the pcb. If  $V_{IN} = 5V$  and  $I_{OUT} = 100mA$  then the power dissipation will be approximately 500mW. Multiplying this by the  $\theta_{JA}$  gives an internal temperature about 100°C higher than the ambient temperature ( $T_A$ ). If the  $T_A$  is 70°C then the internal temperature will be approximately 170°C which will trigger the overtemperature circuit and lead to power-down.

$$\text{Internal temperature} = \text{Ambient temperature} + (\theta_{JA} \times \text{Power dissipation})$$

(Must be less than 170°C)

Note that the evaluation PCB has a  $\theta_{JA}$  of less than 150°C/W, based upon measured performance.

### How to Reduce the Power Dissipation of the Part and How to Get More Than 100mA

If  $V_{IN} = 5V$  typ., then the charge pump / LDO combination is capable of providing more than 100mA. The only problem is power dissipation.

If the input voltage is lowered using an external diode then the output current can be increased without causing the part to overheat. The circuit below illustrates an example of how to increase the output current.

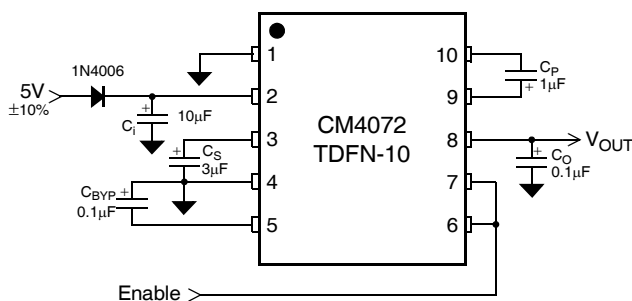

Using this circuit,  $I_{OUT}$  can be 200mA if  $V_{IN} = 4.75V$ , and yet the part will not overheat even if  $V_{IN} = 5.25V$ ,  $I_{OUT}=200mA$  and the ambient temperature is 85°C.

### Warnings

The charge pump output  $V_{CP}$  (pin 3) must not be shorted to GND or held below its internally-set voltage while the part is powered. This usually results in the destruction of the part.

With  $V_{IN} = 5V$ , the maximum current that can be continuously drawn from  $V_{CP}$  is approximately 100mA dc.

Never short  $C_{P+}$  (pin 9) to  $C_{P-}$  (pin 10). This will cause large currents to flow from  $V_{IN}$  to DGND through the part, usually causing its destruction. This will happen even if  $EN\_CP$  and  $EN\_LDO$  are off.

### Troubleshooting Guide

1) *Is the output voltage drooping under heavy loads?* Perhaps the charge pump cannot provide the necessary current. Try increasing the value of  $C_P$ . If that does not work, then, is  $V_{IN}$  too low? Is  $V_{IN}$  dropping during the  $C_P$  charging cycle? If  $V_{IN}$  is not suitably decoupled and drops below 3.1V then the available current will be very low.

2) *Is the output voltage oscillating between 5V and 0V?* The part may be reaching its overtemperature limit. Reduce current consumption, reduce  $\theta_{JA}$  or add an external diode on the input to reduce  $V_{IN}$ .

3) *Is the part too noisy?* Try increasing the value (or reducing ESR) of  $C_S$ ,  $C_{IN}$ ,  $C_S$ ,  $C_B$ . At minimum current the charge pump ripple frequency will be low. If  $V_{OUT}$  noise is at the charge pump ripple frequency, then change values of  $C_P$  and  $C_S$ . Reducing the input voltage  $V_{IN}$  will reduce the charge pump ripple frequency noise on  $V_{OUT}$ .

4) *Will the part power up?* Pin 6 must be HIGH to power up. Even if pin 7 is HIGH, pin 6 must also be high to power up.

5) *Can the cold start power-up time be reduced?* Yes, by reducing the value of the  $C_{BYP}$ .

## Mechanical Details

### TDFN-10 Mechanical Specifications

Dimensions for the CM4072-50DF/DE supplied in a 10-lead TDFN package are presented below.

For complete information on the TDFN-10, see the California Micro Devices TDFN Package Information document.

| PACKAGE DIMENSIONS                 |                                   |      |      |        |       |       |
|------------------------------------|-----------------------------------|------|------|--------|-------|-------|
| Package                            | TDFN                              |      |      |        |       |       |
| JEDEC No.                          | MO-229 (Var. WEED-3) <sup>†</sup> |      |      |        |       |       |
| Leads                              | 10                                |      |      |        |       |       |
| Dim.                               | Millimeters                       |      |      | Inches |       |       |
|                                    | Min                               | Nom  | Max  | Min    | Nom   | Max   |
| A                                  | 0.70                              | 0.75 | 0.80 | 0.028  | 0.030 | 0.031 |
| A1                                 | 0.00                              | 0.02 | 0.05 | 0.000  | 0.001 | 0.002 |
| A2                                 | 0.45                              | 0.55 | 0.65 | 0.018  | 0.022 | 0.026 |
| A3                                 |                                   | 0.20 |      |        | 0.008 |       |
| b                                  | 0.18                              | 0.25 | 0.30 | 0.007  | 0.010 | 0.012 |
| D                                  |                                   | 3.00 |      |        | 0.118 |       |
| D2                                 | 2.20                              | 2.30 | 2.40 | 0.087  | 0.091 | 0.094 |
| E                                  |                                   | 3.00 |      |        | 0.118 |       |
| E2                                 | 1.40                              | 1.50 | 1.60 | 0.055  | 0.060 | 0.063 |
| e                                  |                                   | 0.50 |      |        | 0.020 |       |
| K                                  | 0.20                              |      |      | 0.008  |       |       |
| L                                  | 0.20                              | 0.30 | 0.40 | 0.008  | 0.012 | 0.016 |
| # per tape and reel                | 3000 pieces                       |      |      |        |       |       |
| Controlling dimension: millimeters |                                   |      |      |        |       |       |

<sup>†</sup>This package is compliant with JEDEC standard MO-229, variation WEED-3 with exception of the "D2" and "E2" dimensions as called out in the table above.

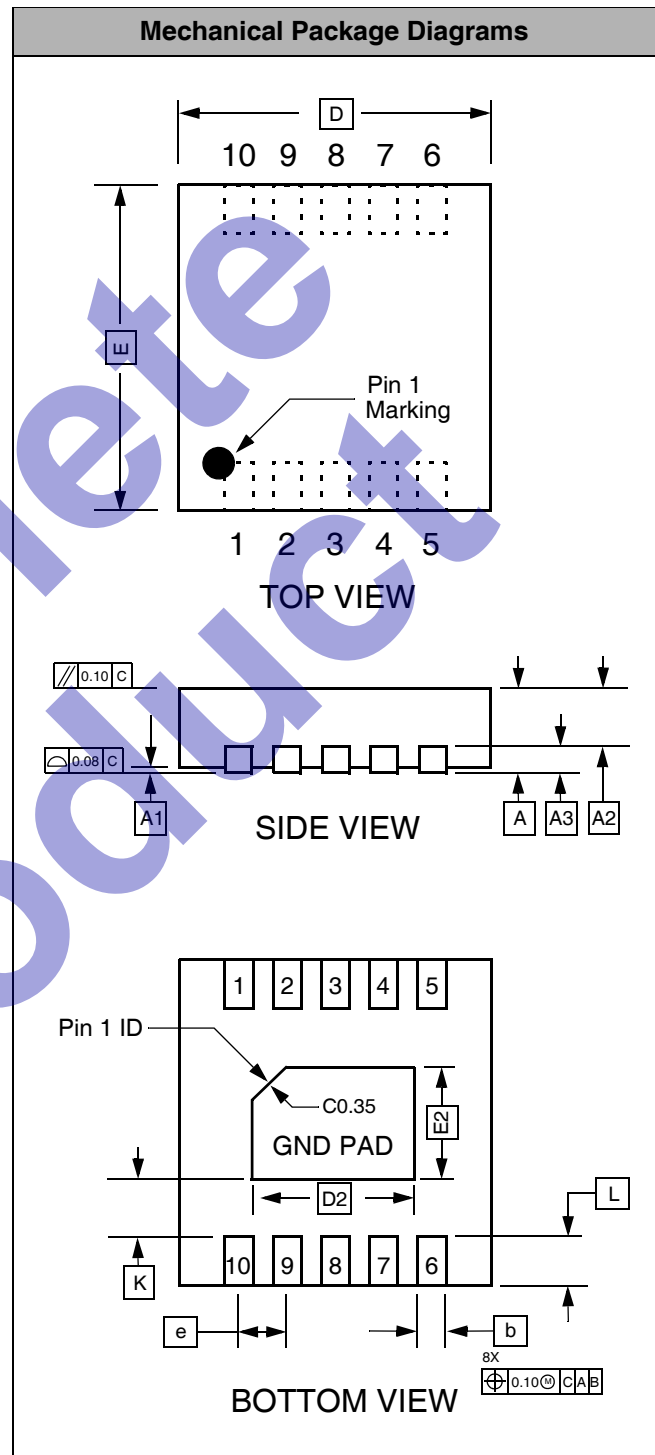

**Package Dimensions for 10-Lead TDFN**